

# CROSS-BOX ENTRY

INTERNATIONAL AEROBATIC CLUB SCORESHEET											
A	Contest:				Date:	Category:	Programme:	pilot's number			
					08/13/2021	Unlimited	Unknown				
No	Symbol	Cat. No.	K	Total K	Grade	Remarks		Item	K	Score	
1		7.4.4.4 9.8.3.2	17 7	24				<b>Presentation</b> 40 <span style="border: 1px solid black; padding: 2px 10px;"> </span>  FIGURE TOTAL K = <span style="border: 1px solid black; padding: 2px 10px;">400</span>  INC. PRESENTATION = <span style="border: 1px solid black; padding: 2px 10px;">440</span>  Aircraft type: <span style="border: 1px solid black; display: inline-block; width: 150px; height: 20px; vertical-align: middle;"></span>          FREE PROGRAM CHECKED BY: Signature: <span style="border: 1px solid black; display: inline-block; width: 100px; height: 20px; vertical-align: middle;"></span> Printed Name: <span style="border: 1px solid black; display: inline-block; width: 100px; height: 20px; vertical-align: middle;"></span> IAC No: <span style="border: 1px solid black; display: inline-block; width: 100px; height: 20px; vertical-align: middle;"></span> Date: <span style="border: 1px solid black; display: inline-block; width: 100px; height: 20px; vertical-align: middle;"></span>  Judge Name: <span style="border: 1px solid black; display: inline-block; width: 150px; height: 20px;"></span>  IAC # <span style="border: 1px solid black; display: inline-block; width: 150px; height: 20px;"></span>  Assistant Name: <span style="border: 1px solid black; display: inline-block; width: 150px; height: 20px;"></span>  IAC # <span style="border: 1px solid black; display: inline-block; width: 150px; height: 20px;"></span>			
2		8.8.6.3 9.10.5.3 9.4.1.4 9.4.5.2	21 13 15 5	54							
3		7.8.5.1 9.4.2.2 9.10.2.2 9.4.2.4 9.1.3.4 9.2.3.4	20 7 15 13 8 9	72							
4		6.2.2.1 9.8.1.2	15 11	26							
5		7.4.5.1 9.2.2.4 9.4.4.4	15 11 11	37							
6		2.3.5.3	36	36							
7		8.4.2.1 9.9.1.3 9.2.5.4	14 15 9	38							
8		8.4.18.2 9.4.2.3 9.1.2.3 9.9.4.2	14 10 8 11	43							
9		8.6.4.2 9.10.1.4 9.2.3.4 9.4.3.2	13 17 9 5	44							
10		1.1.1.2 9.10.3.6 9.8.3.2	3 16 7	26							

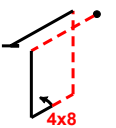
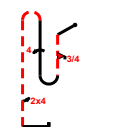
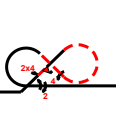
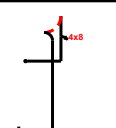
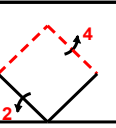
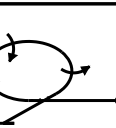
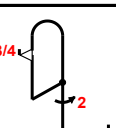
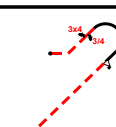
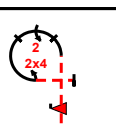
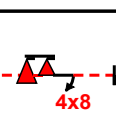

\_\_\_\_\_ Pilot  
 ..... A/C

# CROSS-BOX ENTRY



<b>B</b>	Contest:	Category: <b>Unlimited</b>
	Date: 08/13/2021	Program: <b>Unknown</b>

Pilot: \_\_\_\_\_  
 wind direction

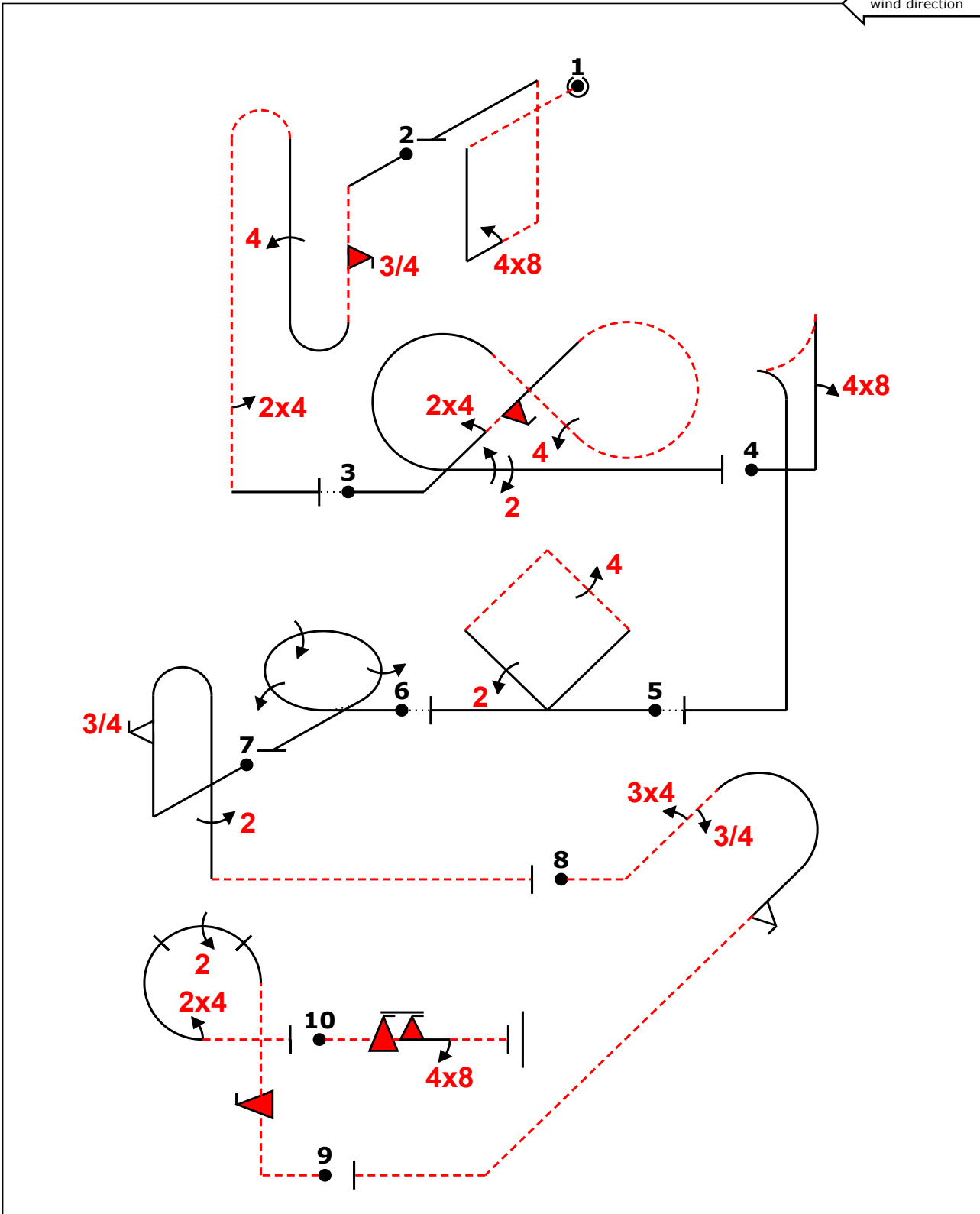

A/C:

(signature/date)

FREE PROGRAM CHECK BY:

# CROSS-BOX ENTRY



<b>C</b>	Contest:	Category:
	Date: 08/13/2021	Program: Unknown
		Pilot's No. <span style="border: 1px solid black; display: inline-block; width: 40px; height: 20px; vertical-align: middle;"></span>

Pilot: .....

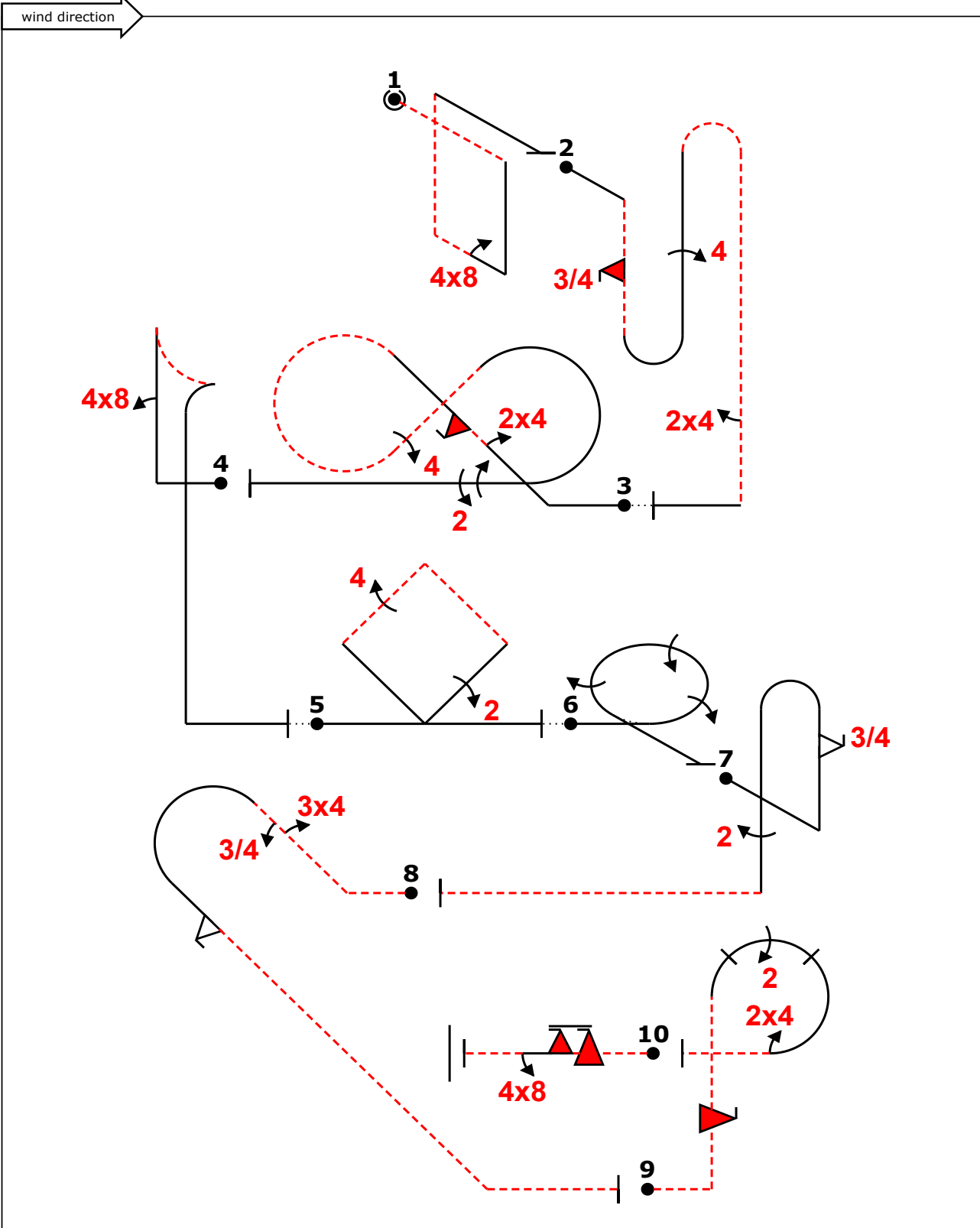

A/C: .....

(signature/date) .....

FREE PROGRAM CHECK BY: .....