

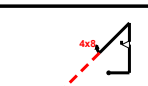

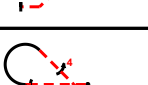
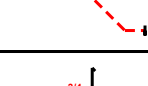
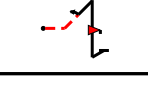
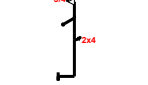
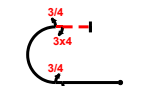

# INTERNATIONAL AEROBATIC CLUB SCORESHEET

# A

Contest: <b>Corvallas Corkscrew</b>	Date: <b>08/07/2020</b>	Category: <b>Unlimited</b>	Programme: <b>Unknown</b>	pilot's number <div style="border: 2px solid black; width: 40px; height: 40px; margin: 0 auto;"></div>
--	----------------------------	-------------------------------	------------------------------	---

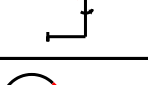
No	Symbol	Cat. No.	K	Total K	Grade	Remarks
1		1.2.1.1 9.4.2.2 9.10.2.2 9.2.5.4	13 7 15 9	44	SF 7	
2		1.2.8.1 9.9.1.2 9.8.4.2	16 15 7	38	SF 7	
3		8.5.7.2 9.1.3.6 9.4.4.4	11 10 11	32	SF 7	
4		5.3.2.4 9.1.2.2 9.1.1.3 9.10.5.4	21 6 10 13	50	SF 5	
5		5.2.1.1 9.9.1.3 9.4.5.2	17 15 5	37	SF 5	
6		7.2.1.1 9.4.3.3 9.1.3.3 9.1.3.3 9.4.3.3	6 8 6 6 8	34	SF 7	
7		1.1.6.4 9.12.1.5 9.1.5.2	10 6 4	20	SF 7	
8		6.2.1.4 9.1.1.1 9.1.5.4	17 6 8	31	SF 6	
9		8.4.13.1 9.2.2.4 9.1.4.4	11 11 8	30	SF 7	
10		7.4.4.2 9.1.3.6	17 10	27	SF 7	
11		8.6.1.1 9.1.1.3 9.1.1.1 9.2.3.4 9.1.3.8	11 10 6 9 12	48	SF 7	
12		1.1.7.1	9	9	SF 7	

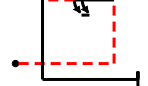
Item	K	Score
<b>Presentation</b>	<b>25</b>	
FIGURE TOTAL K =		400
INC. PRESENTATION =		425
Aircraft type:		

FREE PROGRAM CHECKED BY:

Signature:	Printed Name:	Date:
IAC No:		

Judge Name:
IAC #
Assistant Name:
IAC #



\_\_\_\_\_ Pilot  
 ..... A/C



<b>B</b>	Contest:	Corvallas Corkscrew	Category:	Unlimited
	Date:	08/07/2020	Program:	Unknown
			Pilot's No.	<input type="text"/>

Pilot: \_\_\_\_\_  
wind direction

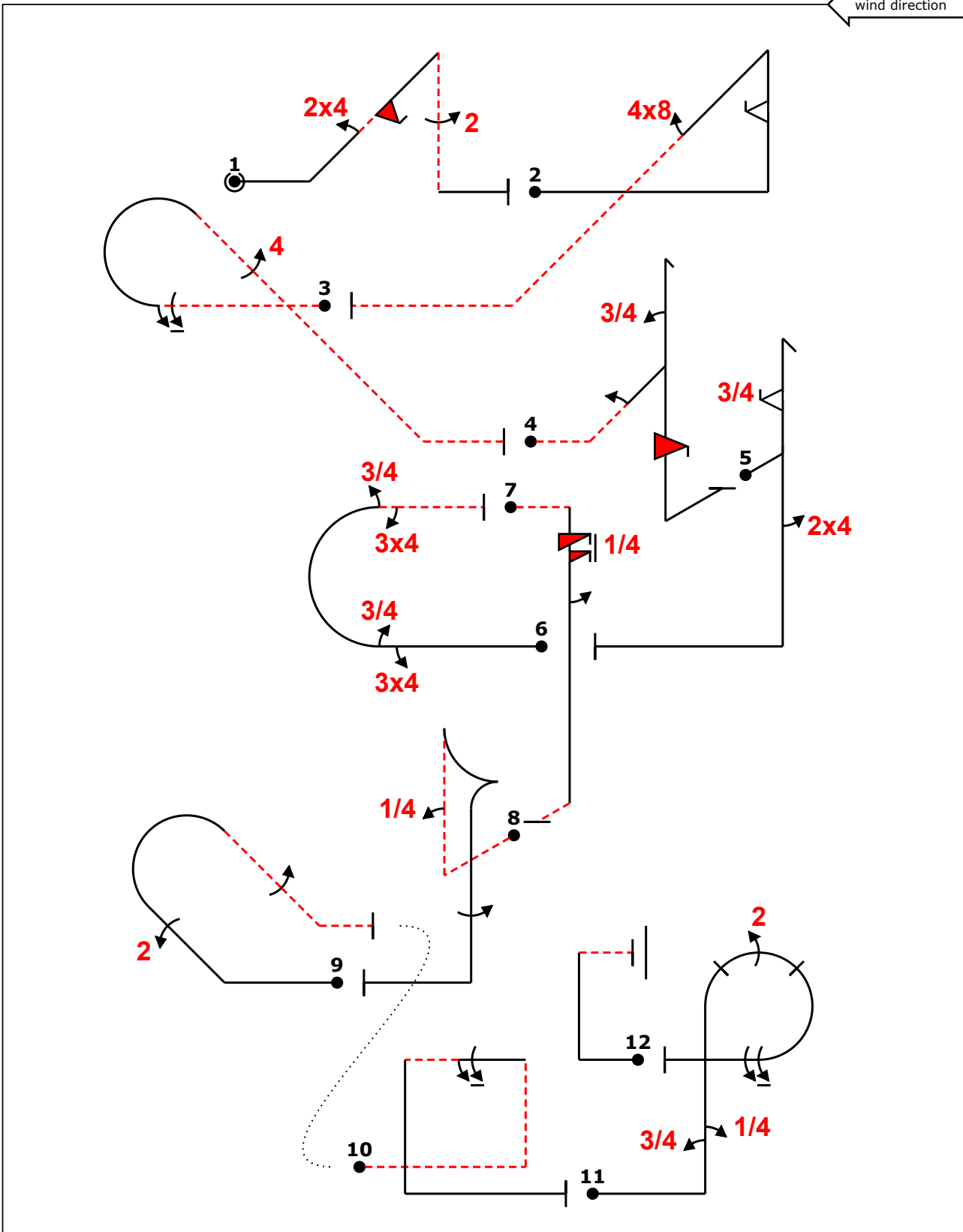

A/C: \_\_\_\_\_

(signature/date) \_\_\_\_\_

FREE PROGRAM CHECK BY: \_\_\_\_\_



<b>C</b>	Contest:	Corvallas Corkscrew	Category:	Unlimited
	Date:	08/07/2020	Program:	Unknown
			Pilot's No.	<input type="text"/>

Pilot:

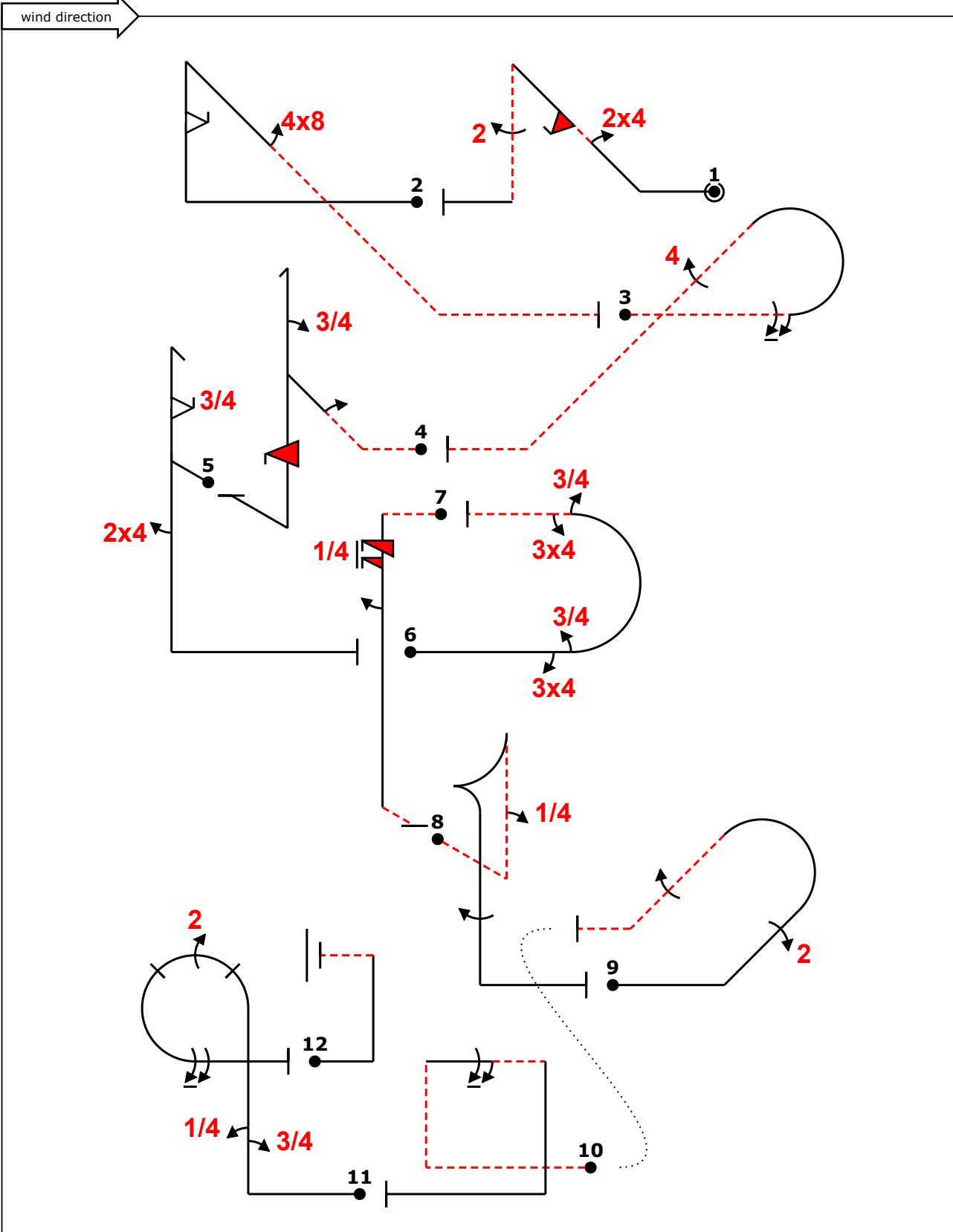

FREE PROGRAM CHECK BY: (signature/date) ..... A/C: .....