

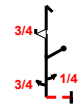

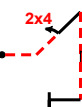





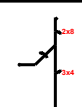

Cross-Box Entry

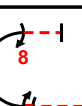
A	INTERNATIONAL AEROBATIC CLUB SCORESHEET						
	Contest: <p style="text-align: center;">Llano, TX</p>	Date: <p style="text-align: center;">10-18-2019</p>	Category: <p style="text-align: center;">Unlimited</p>	Programme: <p style="text-align: center;">Unknown</p>	pilot's number		

No	Symbol	Cat. No.	K	Total K	Grade	Remarks
1		5.2.1.3 9.9.1.3 9.1.5.1 9.1.5.3	18 15 2 6	41		
2		1.2.4.2 9.4.2.2 9.10.5.2	14 7 13	34		
3		8.4.14.1 9.2.2.4 9.8.4.2	12 11 7	30		
4		5.3.1.1 9.1.2.4 9.8.1.1 9.4.5.3	18 10 7 8	43		
5		7.4.2.1 9.1.3.6	12 10	22		
6		7.2.3.2 9.1.3.4 9.1.3.2 9.8.3.4	7 8 4 15	34		
7		7.2.4.4 9.1.3.2 9.4.3.2	8 4 5	17		
8		7.3.2.1 9.10.7.2 9.4.2.4	14 17 13	44		
9		8.6.5.3 9.1.1.3 9.1.1.2	16 10 8	34		
10		2.3.3.3	38	38		
11		8.4.4.2 9.4.1.2 9.9.5.2	14 9 11	34		
12		1.1.6.1 9.10.6.3	10 19	29		

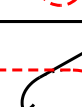
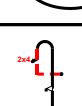
Presentation	40	
---------------------	----	--

FIGURE TOTAL K =	400
------------------	-----

INC. PRESENTATION =	440
---------------------	-----

Aircraft type:

FREE PROGRAM CHECKED BY:

Signature:	Printed Name:	Date:
IAC No:		

Judge Name:

IAC #

Assistant Name:

IAC #



_____ Pilot
 A/C

Cross-Box Entry



B	Contest:	Llano, TX	Category:	Unlimited
	Date:	10-18-2019	Program:	Unknown
Pilot's No. <input type="text"/>			Pilot's No. <input type="text"/>	

Pilot:

wind direction

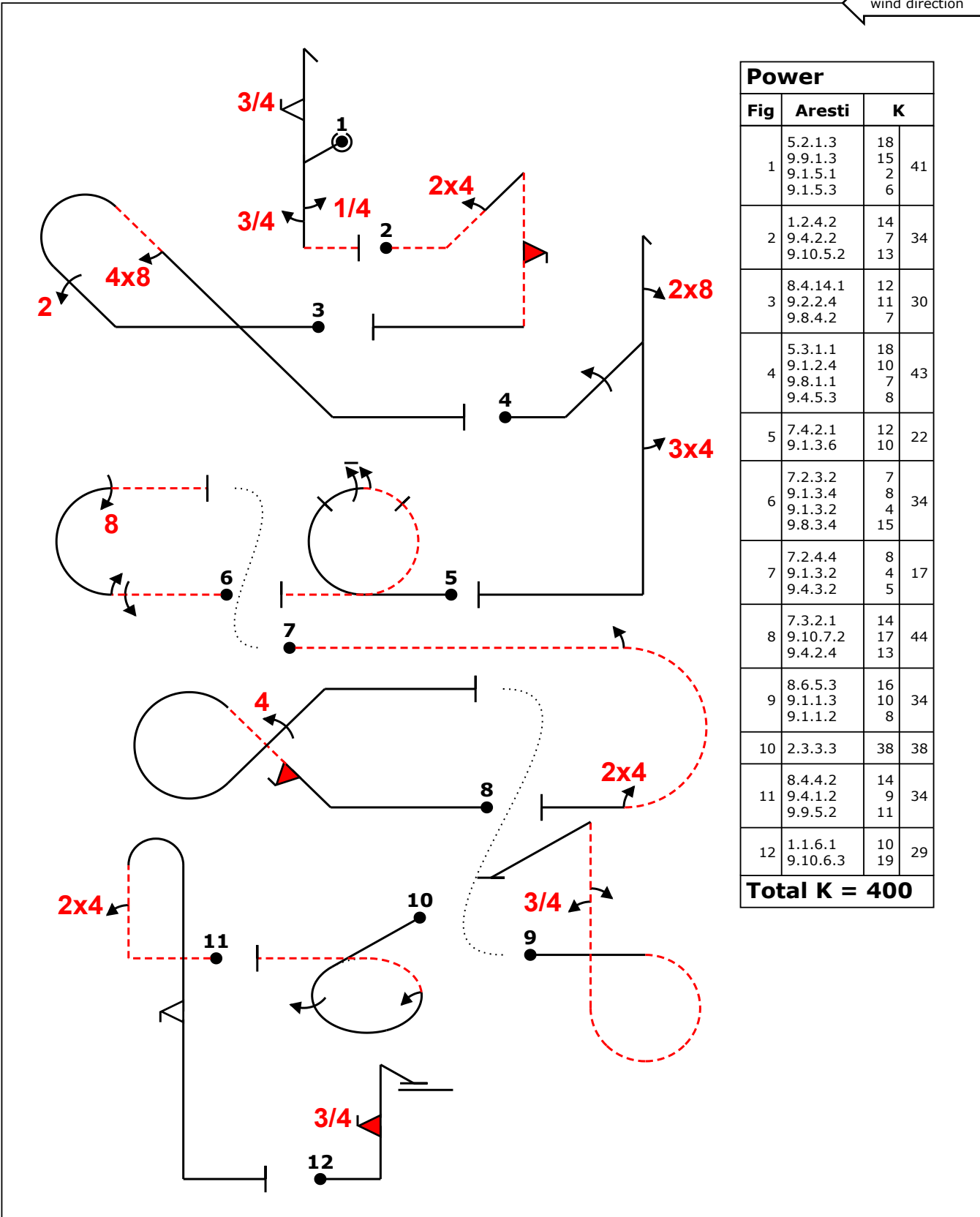

Power			
Fig	Aresti	K	
1	5.2.1.3	18	41
	9.9.1.3	15	
	9.1.5.1	2	
	9.1.5.3	6	
2	1.2.4.2	14	34
	9.4.2.2	7	
	9.10.5.2	13	
3	8.4.14.1	12	30
	9.2.2.4	11	
	9.8.4.2	7	
4	5.3.1.1	18	43
	9.1.2.4	10	
	9.8.1.1	7	
	9.4.5.3	8	
5	7.4.2.1	12	22
	9.1.3.6	10	
6	7.2.3.2	7	34
	9.1.3.4	8	
	9.1.3.2	4	
	9.8.3.4	15	
7	7.2.4.4	8	17
	9.1.3.2	4	
	9.4.3.2	5	
8	7.3.2.1	14	44
	9.10.7.2	17	
	9.4.2.4	13	
9	8.6.5.3	16	34
	9.1.1.3	10	
	9.1.1.2	8	
10	2.3.3.3	38	38
11	8.4.4.2	14	34
	9.4.1.2	9	
	9.9.5.2	11	
12	1.1.6.1	10	29
	9.10.6.3	19	
Total K = 400			

A/C:

(signature/date)

FREE PROGRAM CHECK BY:

Cross-Box Entry



C	Contest:	Llano, TX	Category:	Unlimited
	Date:	10-18-2019	Program:	Unknown
			Pilot's No.	<input style="width: 50px; height: 20px;" type="text"/>

Pilot:

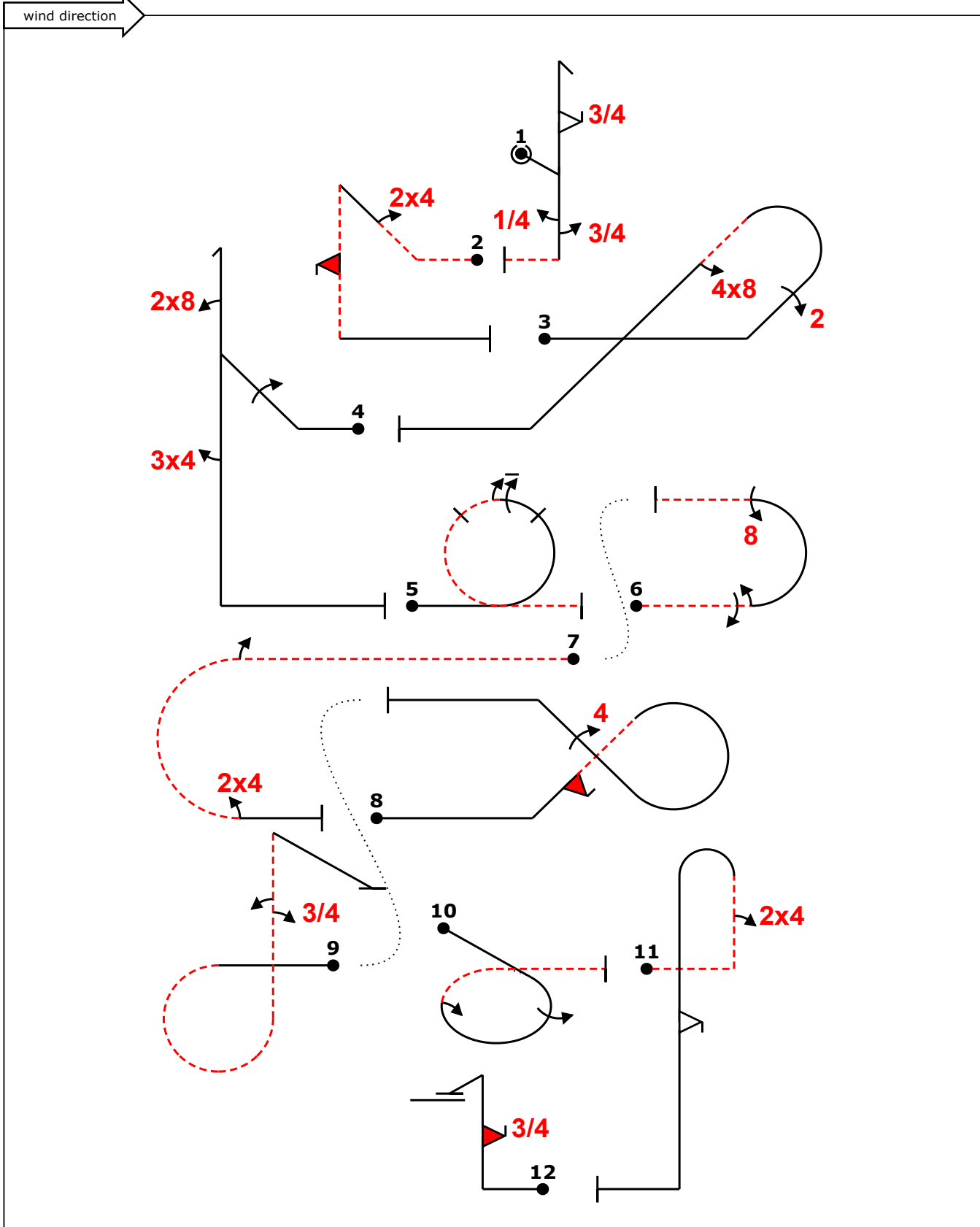

A/C:

(signature/date)

FREE PROGRAM CHECK BY: