















# NOTE DOWNWIND ENTRY

A	INTERNATIONAL AEROBATIC CLUB SCORESHEET				
	Contest: <p style="text-align: center;">Nationals</p>	Date: <p style="text-align: center;">2021</p>	Category: <p style="text-align: center;">Unlimited</p>	Programme: <p style="text-align: center;">Unknown2</p>	pilot's number <div style="border: 2px solid black; width: 40px; height: 40px; margin: 0 auto;"></div>

No	Symbol	Cat. No.	K	Total K	Grade	Remarks
1		8.6.2.2 9.8.1.1 9.1.1.3 9.9.8.4 9.1.3.5 9.1.3.7	16 7 10 13 9 11	Fig A 66 SF 7		
2		5.2.1.1 9.1.1.4 9.10.5.4	17 12 13	Fig C 42 SF 5		
3		8.4.13.1 9.8.2.1 9.1.2.5 9.9.9.4	11 5 11 13	Fig B 40 SF 7		
4		5.2.1.4 9.1.1.5 9.1.5.4	22 14 8	Fig G 44 SF 5		
5		8.4.1.1 9.1.5.1	13 2	additional 6 SF 7		
6		8.6.1.1 9.2.1.4 9.4.3.4 9.1.3.2 9.1.3.6	11 13 11 4 10	Fig I 49 SF 7		
7		8.4.1.1 9.1.1.1 9.1.5.1	13 6 2	additional 6 SF 7		
8		6.2.2.1 9.10.6.3 9.1.5.3	15 19 6	Fig F 40 SF 6		
9		1.2.8.1 9.4.1.2 9.1.4.6	16 9 10	Fig H 35 SF 7		
10		7.2.2.2 9.1.3.3 9.4.3.3 9.10.3.4 9.8.3.2	9 6 8 13 7	Fig E 43 SF 7		
11		8.4.2.2	17	additional 6 SF 7		
12		8.8.1.1 9.9.1.4 9.4.5.3 9.4.1.3	18 15 8 12	Fig D 53 SF 7		
13		8.4.1.4 9.1.5.1	13 2	additional 6 SF 7		
14		8.6.2.4 9.12.1.5 9.1.5.2 9.8.3.4 9.4.3.2	12 6 4 15 5	Fig J 42 SF 7		

<b>Presentation</b>	40						
FIGURE TOTAL K =				478			
INC. PRESENTATION =				518			
Aircraft type:							
FREE PROGRAM CHECKED BY:							
Signature:		Printed Name:		IAC No:		Date:	
Judge Name:							
IAC #							
Assistant Name:							
IAC #							



Pilot

A/C

# NOTE DOWNWIND ENTRY



<b>B</b>	Contest:	Nationals	Category:	Unlimited
	Date:	2021	Program:	Unknown2
			Pilot's No.	

Pilot: \_\_\_\_\_

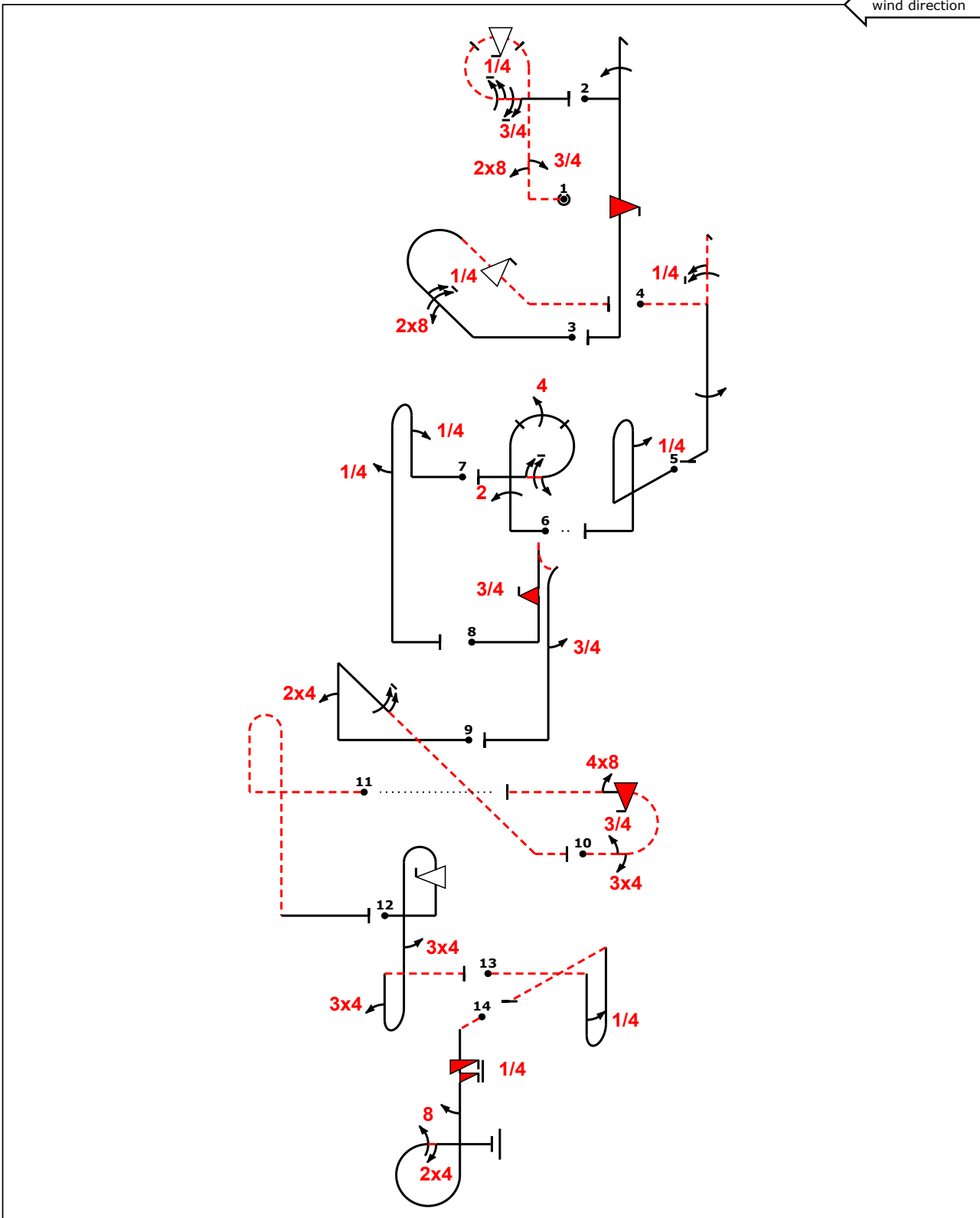

A/C: \_\_\_\_\_

FREE PROGRAM CHECK BY: (signature/date) \_\_\_\_\_

# NOTE DOWNWIND ENTRY



<b>C</b>	Contest:	Nationals		Category:	Unlimited
	Date:	2021	Program:	Unknown2	
			Program:	Pilot's No.	

Pilot:

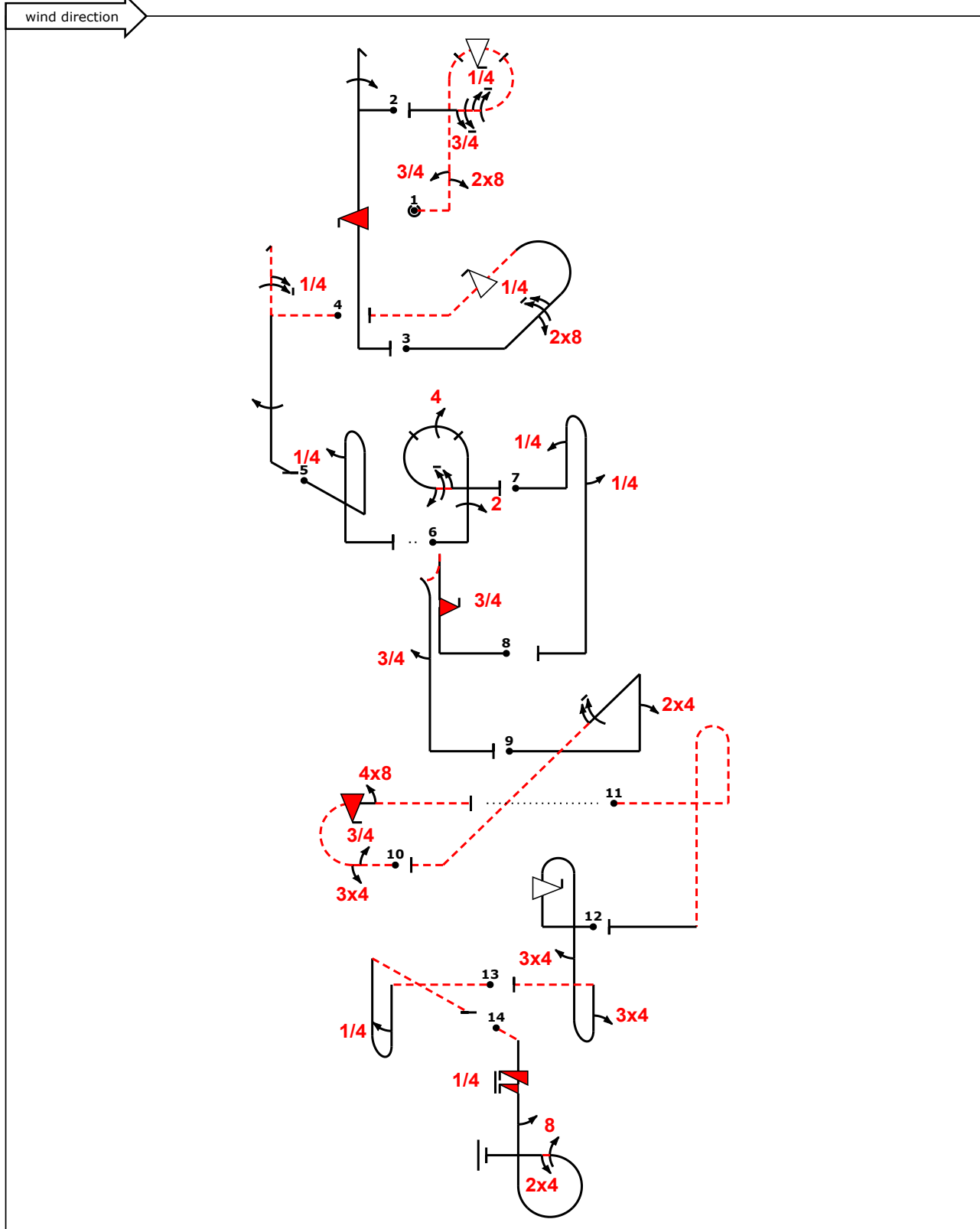

A/C: \_\_\_\_\_  
 (signature/date) \_\_\_\_\_  
 FREE PROGRAM CHECK BY: \_\_\_\_\_