

Cross-box Entry

INTERNATIONAL AEROBATIC CLUB SCORESHEET											
A	Contest:				Date:	Category:	Programme:	pilot's number			
						Intermediate	Unknown				
No	Symbol	Cat. No.	K	Total K	Grade	Remarks			Item	K	Score
1		1.1.7.1 9.1.1.1	9 6	15					Presentation	15	
2		7.3.4.4 9.1.4.2 9.4.4.2	15 4 5	24							
3		7.2.2.1 9.4.3.2	6 5	11					INC. PRESENTATION =	187	
4		1.1.6.3 9.11.1.4	10 5	15					Aircraft type:		
5		5.2.1.1	17	17							
6		8.4.3.1 9.1.5.1	15 2	17					FREE PROGRAM CHECKED BY:		
7		1.2.6.1 9.1.1.1	14 6	20							
8		7.4.1.1 9.9.3.4	10 11	21					Judge Name:		
9		7.2.1.1	6	6							
10		1.1.1.4 9.1.3.6	2 10	12					Assistant Name:		
11		2.1.3.1	14	14							

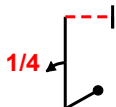
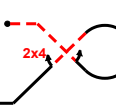
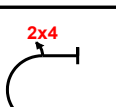
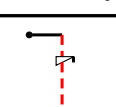
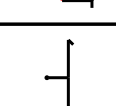
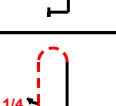
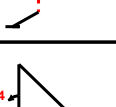
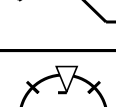
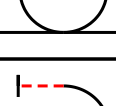
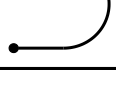
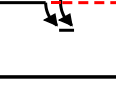

_____ Pilot
 A/C

Cross-box Entry



B	Contest:	Category: Intermediate
	Date:	Program: Unknown
		Pilot's No.

Pilot: _____
 wind direction

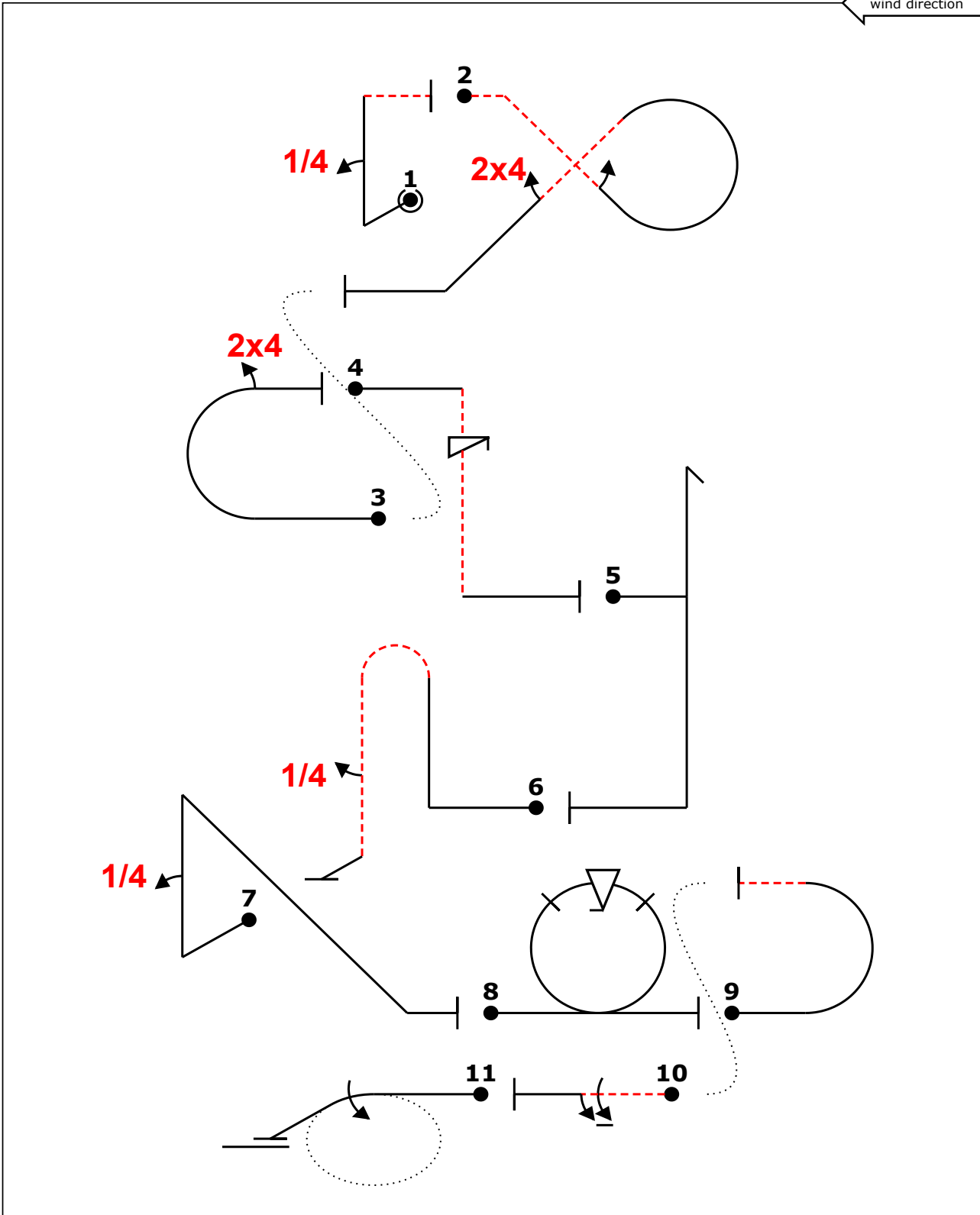

A/C: _____

(signature/date) _____

FREE PROGRAM CHECK BY: _____

Cross-box Entry



C	Contest:	Category: Intermediate
	Date:	Program: Unknown
		Pilot's No.

Pilot:

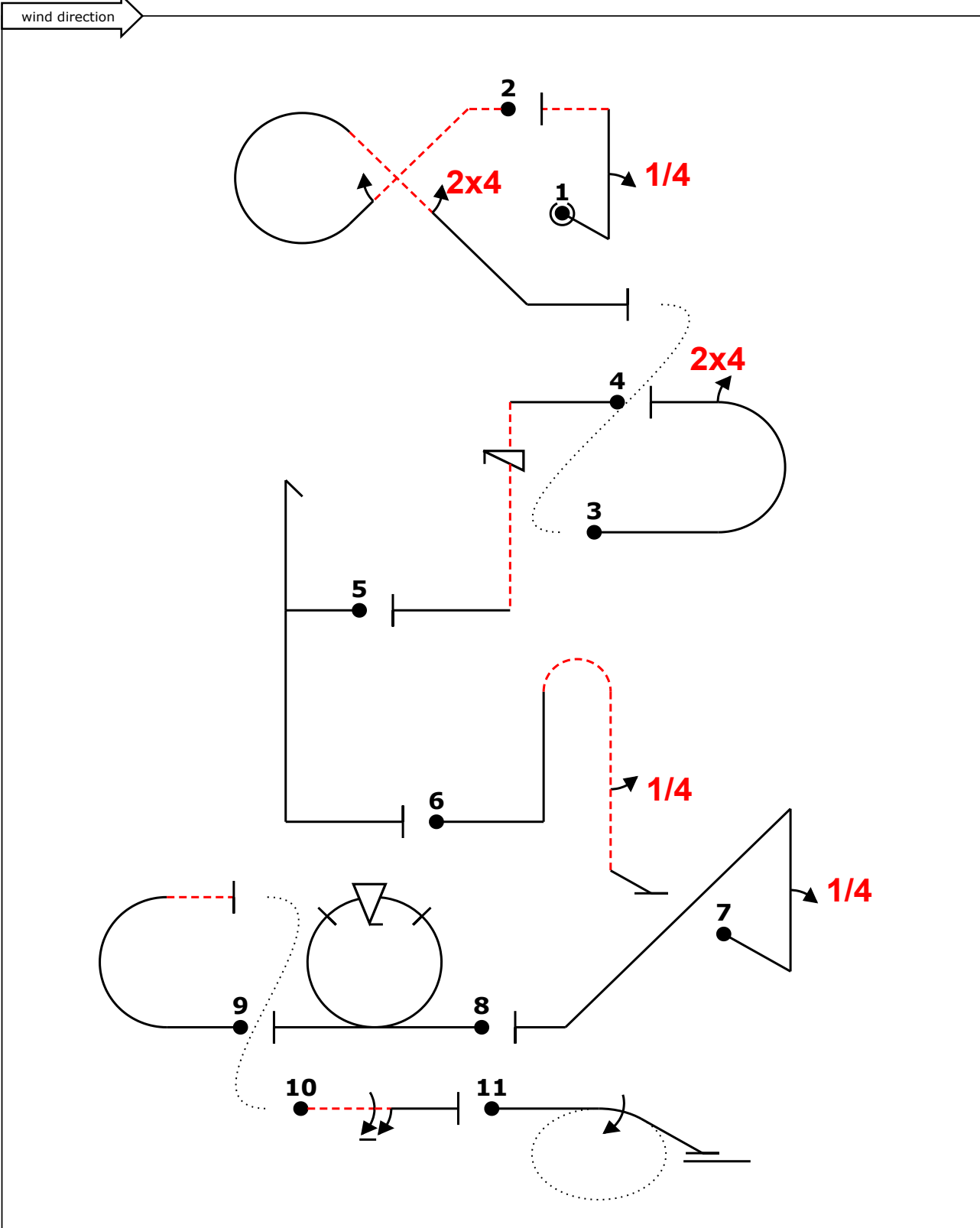

A/C:

(signature/date)

FREE PROGRAM CHECK BY: