

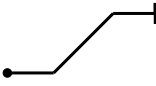
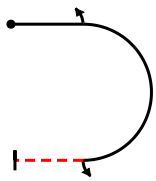
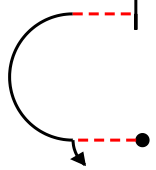
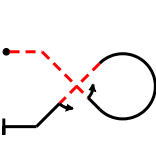
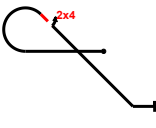
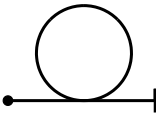
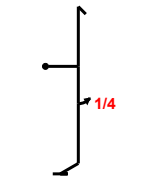
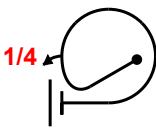

INTERNATIONAL AEROBATIC CLUB SCORESHEET

A

Contest: US Nationals Glider	Date: 9/27/2019	Category: Intermediate Glider	Programme: Unknown	pilot's number	
--	---------------------------	---	------------------------------	----------------	--

No	Symbol	Cat. No.	K	Total K	Grade	Remarks	Item	K	Score						
1		1.1.2.1	7	7			Presentation	15							
				SF 7			FIGURE TOTAL K =		129						
2		7.2.4.3 9.1.3.2 9.1.3.2	6 6 6	18			INC. PRESENTATION =		144						
				SF 7			Aircraft type:								
3		7.2.3.2 9.1.3.2	7 6	13			FREE PROGRAM CHECKED BY: <table border="1" style="width: 100%; border-collapse: collapse;"> <tr> <td style="width: 33%; height: 150px; vertical-align: bottom;">Signature:</td> <td style="width: 33%; height: 150px; vertical-align: bottom;">Printed Name:</td> <td style="width: 33%; height: 150px; vertical-align: bottom;">Date:</td> </tr> <tr> <td style="width: 33%; height: 50px; vertical-align: bottom;">IAC No:</td> <td colspan="2"></td> </tr> </table>			Signature:	Printed Name:	Date:	IAC No:		
Signature:	Printed Name:	Date:													
IAC No:															
4		7.3.4.4 9.1.4.2 9.1.4.2	15 6 6	27											
				SF 7											
5		8.5.6.1 9.4.4.2	10 8	18											
				SF 7											
6		7.4.1.1	10	10			Judge Name:								
				SF 7			IAC #								
7		5.2.1.1 9.1.5.1	17 3	20			Assistant Name:								
				SF 5			IAC #								
8		0.1	16	16											
				SF 7											



_____ Pilot
 _____ A/C



B	Contest:	US Nationals Glider	Category:	Intermediate Glider
	Date:	9/27/2019	Program:	Unknown
			Pilot's No.:	

Pilot: _____

wind direction ←

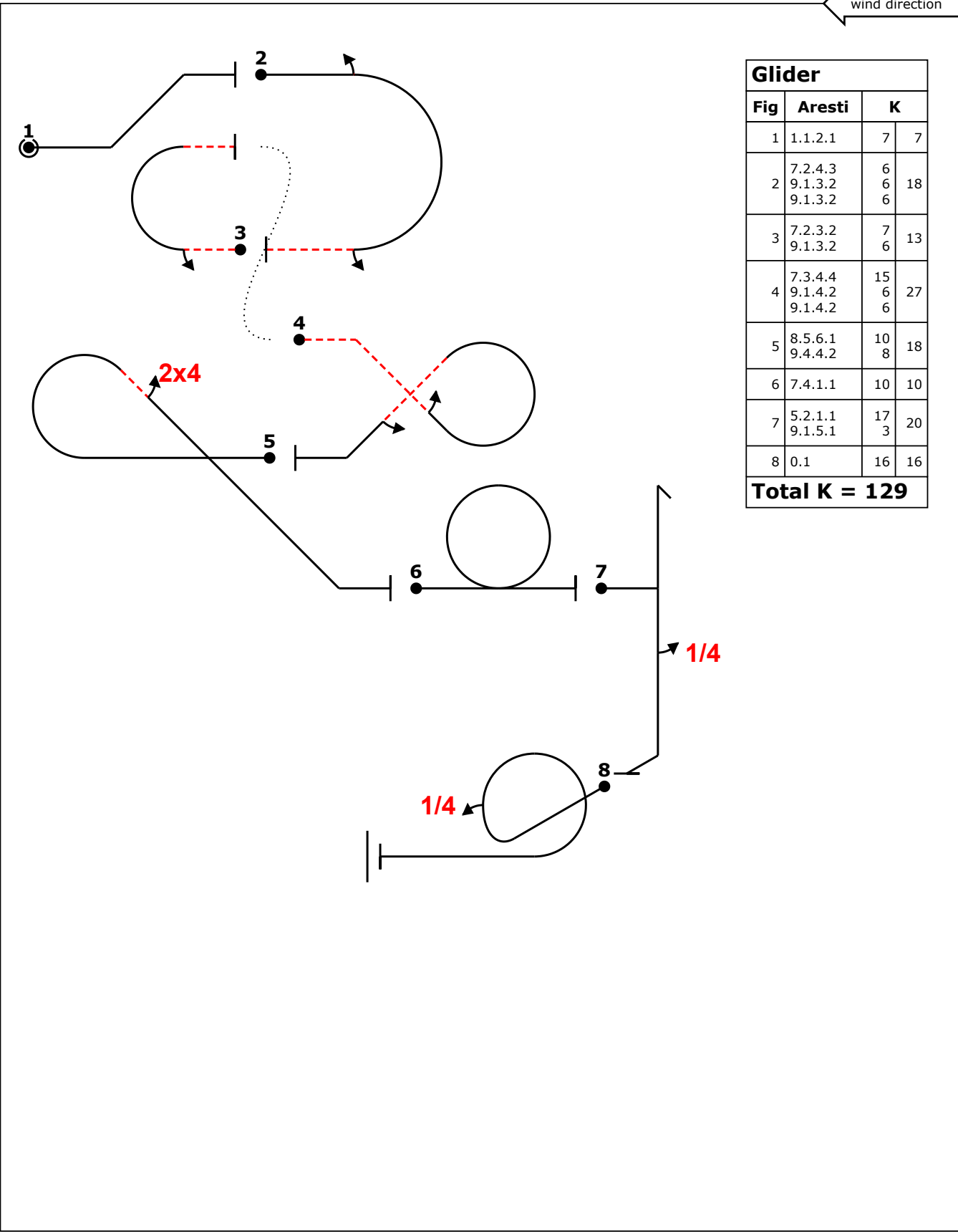

Glider			
Fig	Aresti	K	
1	1.1.2.1	7	7
2	7.2.4.3	6	18
	9.1.3.2	6	
	9.1.3.2	6	
3	7.2.3.2	7	13
	9.1.3.2	6	
4	7.3.4.4	15	27
	9.1.4.2	6	
	9.1.4.2	6	
5	8.5.6.1	10	18
	9.4.4.2	8	
6	7.4.1.1	10	10
7	5.2.1.1	17	20
	9.1.5.1	3	
8	0.1	16	16
Total K = 129			

A/C: _____

(signature/date)

FREE PROGRAM CHECK BY: _____



C	Contest:	US Nationals Glider	Category:	Intermediate Glider
	Date:	9/27/2019	Program:	Unknown
			Pilot's No.	<input type="text"/>

Pilot:

wind direction

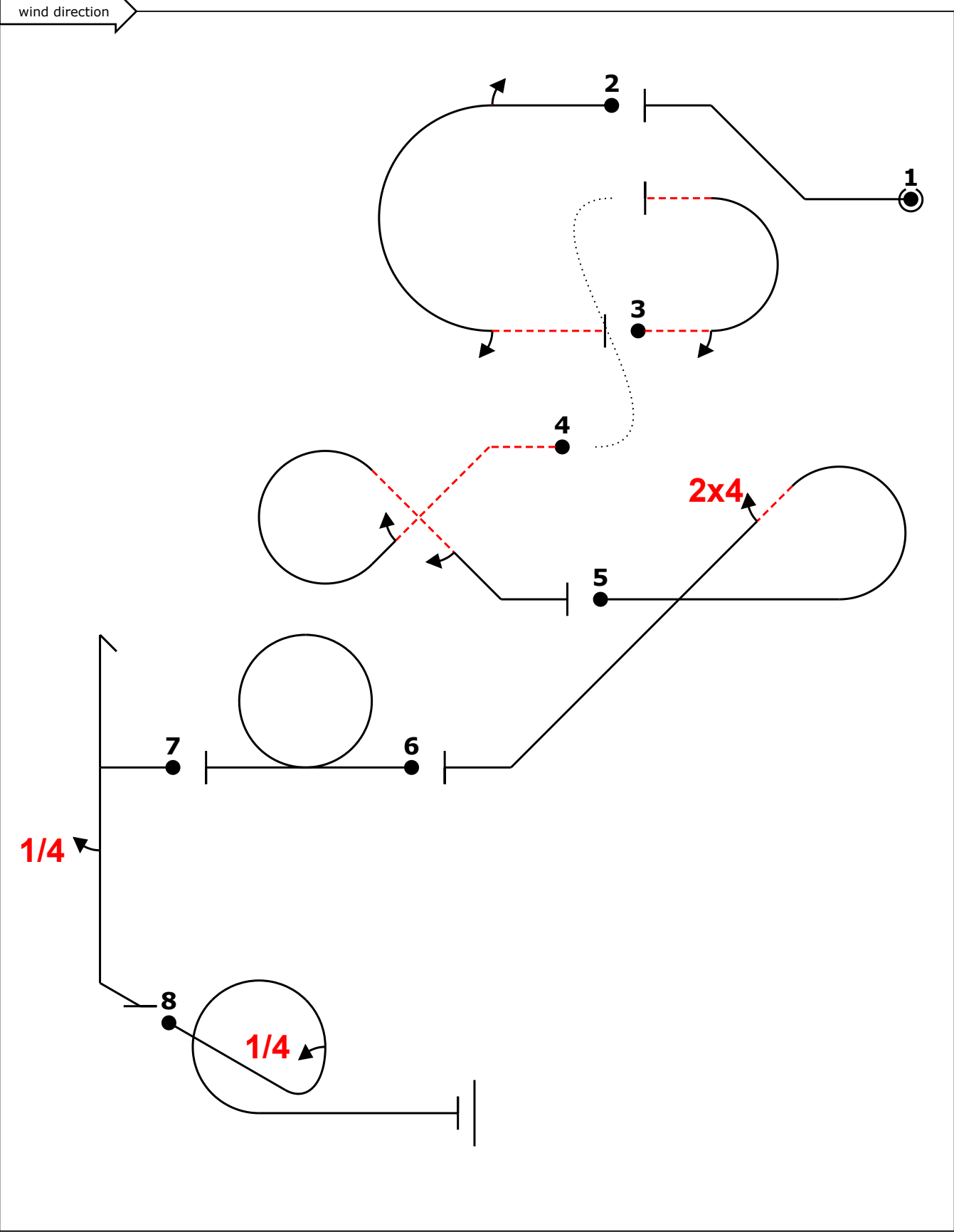

A/C:

(signature/date)

FREE PROGRAM CHECK BY: