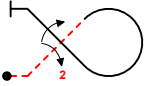
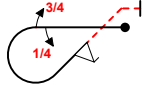
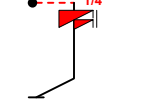
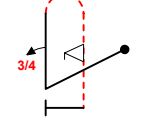
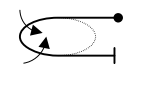
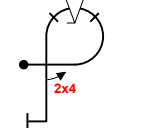
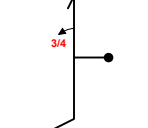
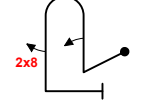
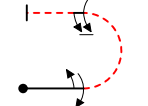
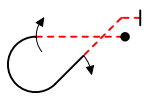

INTERNATIONAL AEROBATIC CLUB SCORESHEET

A

Contest:	Date:	Category: Advanced	Programme: Unknown	pilot's number	
----------	-------	------------------------------	------------------------------	----------------	--

No	Symbol	Catalogue No.	K	Total K	Grade	Remarks
1		7.3.1.2 9.2.2.4 9.1.2.4	14 11 10	35		
2		8.5.8.3 9.1.3.1 9.1.3.3 9.9.2.2	11 2 6 13	32		
3		1.1.7.4 9.12.1.5	9 6	15		
4		8.4.3.1 9.1.1.3 9.9.10.2	15 10 13	38		
5		2.2.5.1	22	22		
6		8.6.5.1 9.9.3.4 9.4.5.2	11 11 5	27		
7		5.2.1.1 9.1.1.3	17 10	27		
8		8.4.1.1 9.1.1.2 9.8.5.1	13 8 3	24		
9		7.2.4.1 9.1.3.2 9.1.3.4 9.1.3.6	8 4 8 10	30		
10		8.5.6.4 9.1.3.4 9.1.2.2	11 8 6	25		

Presentation	12	
--------------	----	--

FIGURE TOTAL K = 275

INCLUDING PRESENTATION = 287

Aircraft Type:

FREE PROGRAM CHECKED BY:

Signature:	Printed Name:	Date:
		IAC No.

Judge Name:

IAC#

Assistant Name:

IAC#



Pilot NAC



B	Contest:	Category: Advanced	
	Date:	Program: Unknown	Pilot's No. <input type="text"/>

wind direction

Pilot
NAC

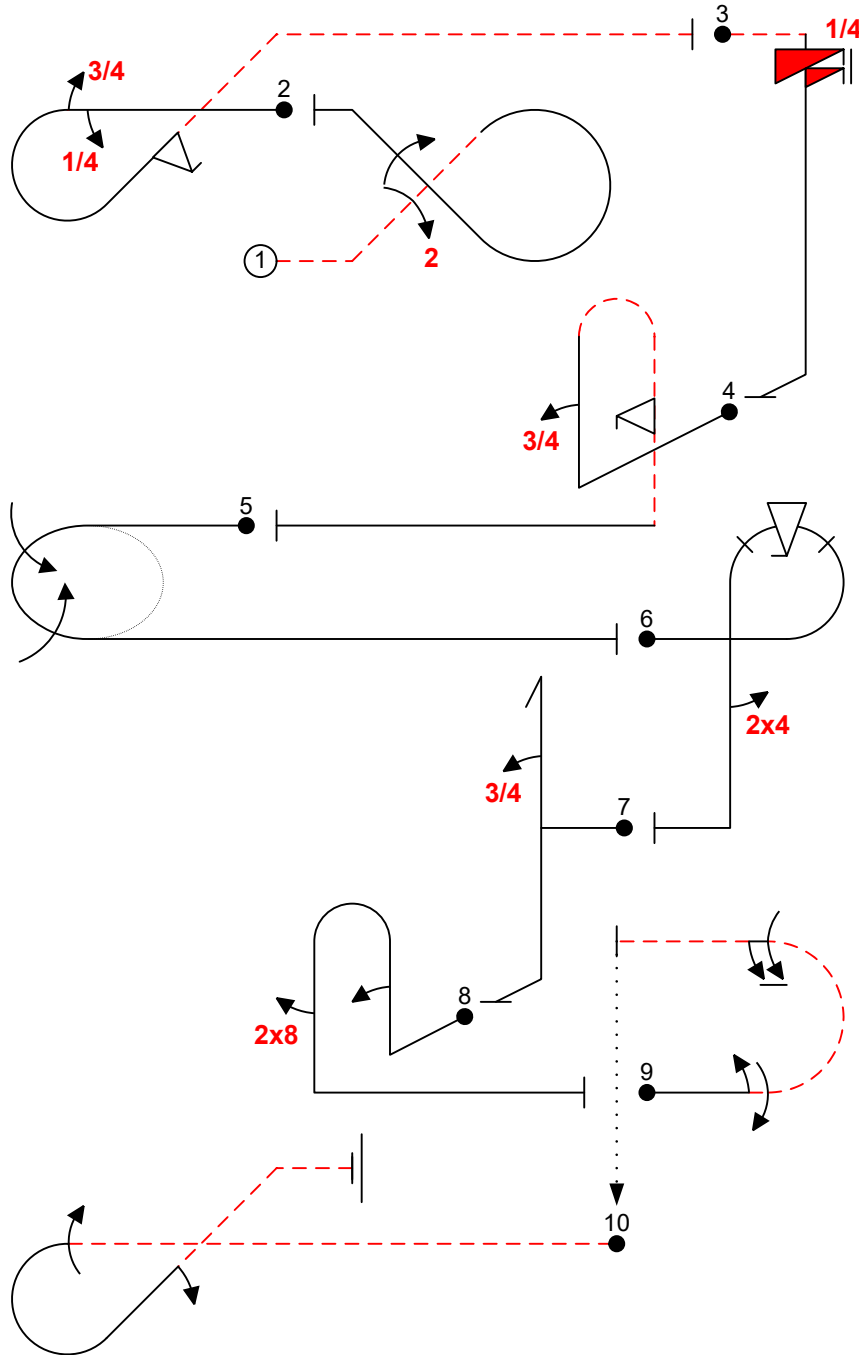

Created Using Aresti 2013™ software. ACCassidy@aol.com

A/C:

(signature/date)

FREE PROGRAM CHECK BY:



C	Contest:	Category: Advanced	
	Date:	Program: Unknown	Pilot's No. <input type="text"/>

pilot
NAC

wind direction

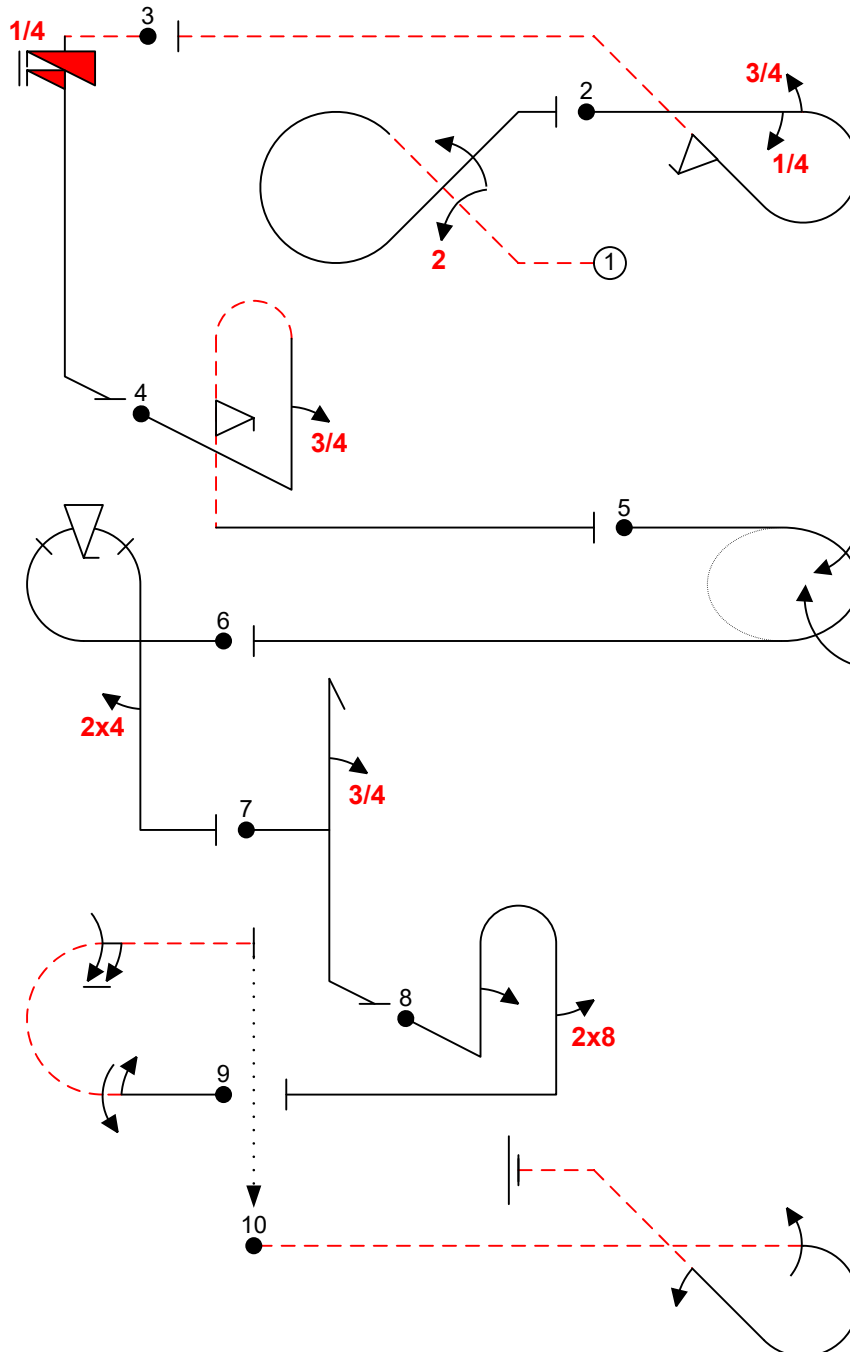

A/C:

(signature/date)

FREE PROGRAM CHECK BY: