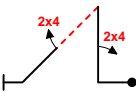
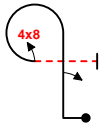
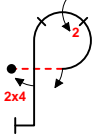
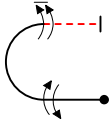
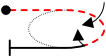
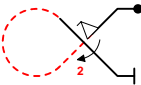
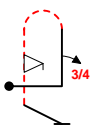
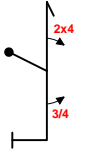
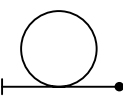
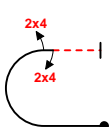

INTERNATIONAL AEROBATIC CLUB SCORESHEET

A

Contest:	Date:	Category: Advanced	Programme: Unknown	pilot's number	
----------	-------	------------------------------	------------------------------	----------------	--

No	Symbol	Catalogue No.	K	Total K	Grade	Remarks
1		1.2.7.1 9.4.1.2 9.4.4.2	13 9 5	27		
2		8.6.2.1 9.1.1.2 9.8.3.2	12 8 7	27		
3		8.6.7.2 9.1.3.2 9.2.3.4 9.4.5.2	12 4 9 5	30		
4		7.2.1.1 9.1.3.4 9.1.3.4 9.1.3.8	6 8 8 12	34		
5		2.2.3.2	24	24		
6		7.3.2.3 9.9.4.2 9.2.4.4	17 11 9	37		
7		8.4.3.1 9.1.1.3 9.9.10.2	15 10 13	38		
8		5.2.1.1 9.4.1.2 9.1.5.3	17 9 6	32		
9		7.4.1.1	10	10		
10		7.2.1.1 9.4.3.2 9.4.3.2	6 5 5	16		

Presentation	12	
---------------------	-----------	--

FIGURE TOTAL K = **275**

INCLUDING PRESENTATION = **287**

Aircraft Type:

FREE PROGRAM CHECKED BY:

Signature:	Printed Name:	Date:
		IAC No.

Judge Name:

IAC#

Assistant Name:

IAC#



Pilot NAC



B	Contest:	Category: Advanced	
	Date:	Program: Unknown	Pilot's No.

wind direction

Pilot
NAC

NOTE DOWNWIND START

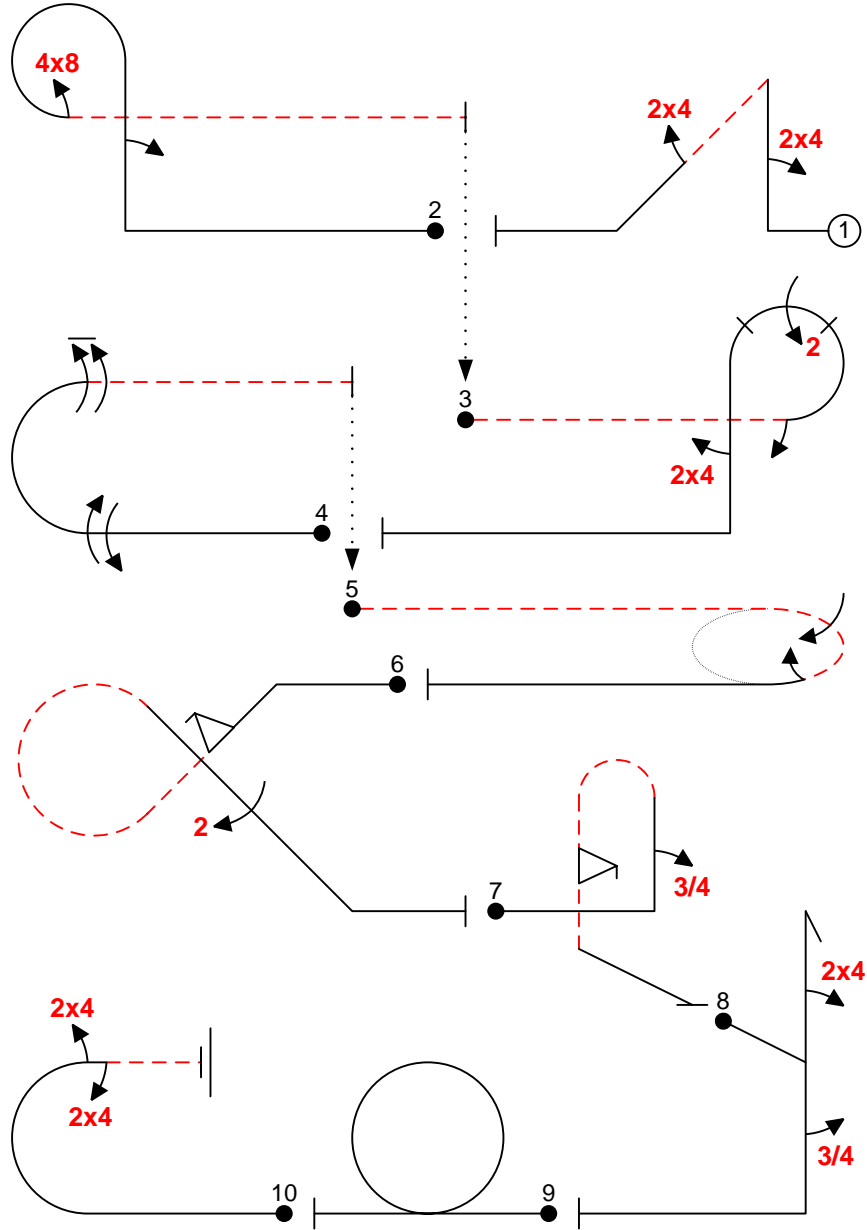

A/C:

(signature/date)

FREE PROGRAM CHECK BY:



C	Contest:	Category: Advanced	
	Date:	Program: Unknown	Pilot's No. <input type="text"/>

pilot
NAC

wind direction

NOTE DOWNWIND START

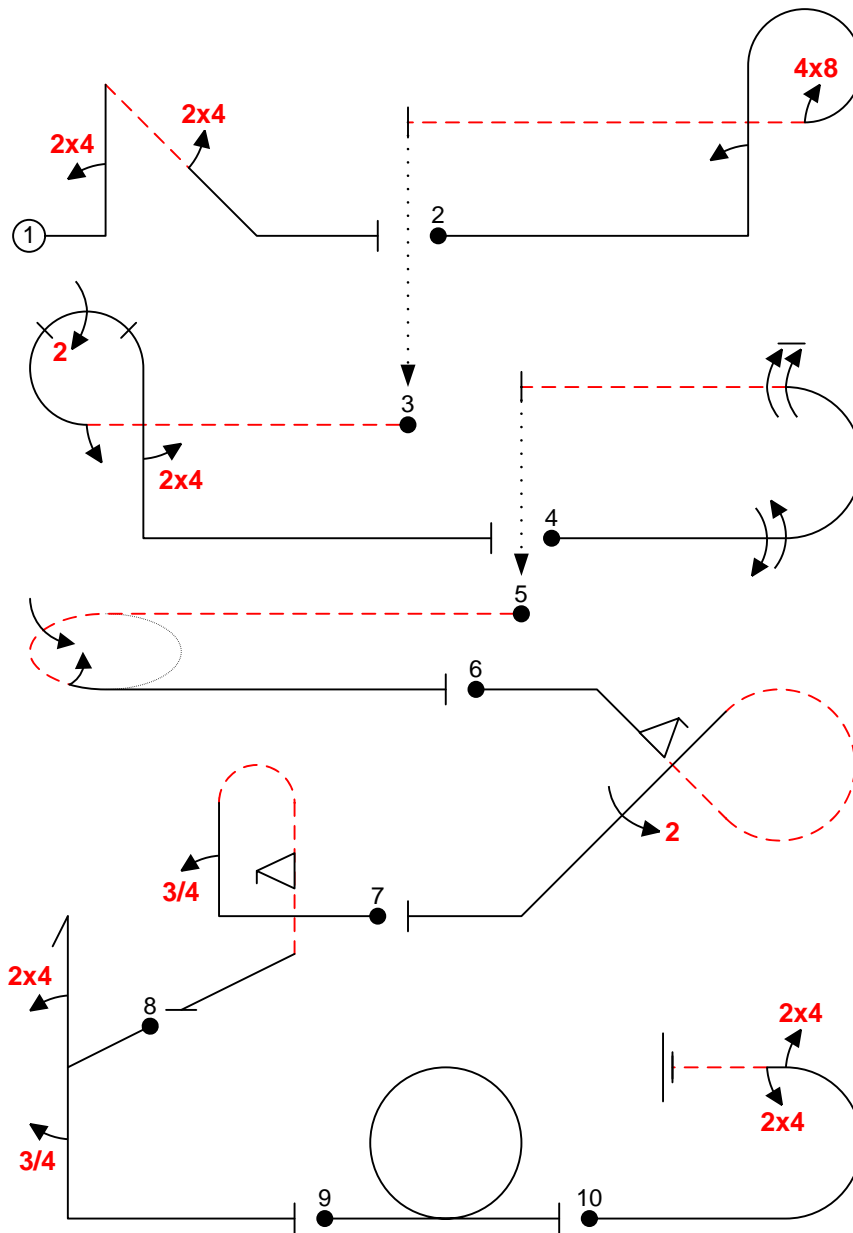

Created Using Aresti 2013™ software. ACCassidy@aol.com

A/C:

(signature/date)

FREE PROGRAM CHECK BY: