

INTERNATIONAL AEROBATIC CLUB SCORESHEET

A	Contest:	Date:	Category: Advanced	Programme: Unknown	pilot's number	



No	Symbol	Catalogue No.	K	Total K	Grade	Remarks	Item	K	Score
1		1.2.1.3 9.2.4.4 9.8.1.1	13 9 7	29			Presentation	12	
2		2.1.3.3	15	15					
3		7.2.4.3 9.1.3.6 9.2.3.6	6 10 12	28					
4		7.3.4.4 9.1.4.2 9.4.4.2	15 4 5	24					
5		8.6.2.1 9.1.1.2 9.1.3.1 9.1.3.3	12 8 2 6	28					
6		5.3.1.4 9.1.1.1 9.9.5.3	23 6 11	40					
7		7.4.3.1 9.1.3.4	14 8	22					
8		7.2.2.1 9.9.3.2	6 11	17					
9		2.2.5.1	22	22					
10		8.5.8.3 9.1.3.6 9.8.2.2	11 10 9	30					
11		8.5.1.4 9.1.3.4	12 8	20					

FIGURE TOTAL K = **275**

INCLUDING PRESENTATION = **287**

Aircraft Type:

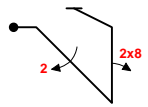
FREE PROGRAM CHECKED BY:

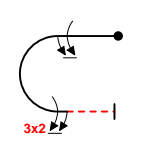
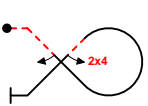
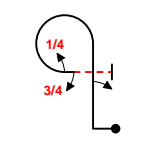
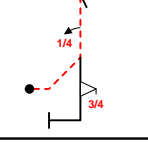
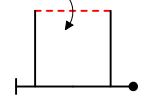
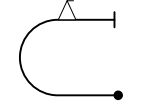
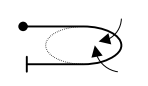
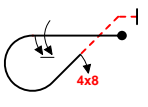
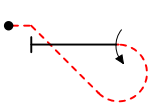
Signature:	Printed Name:	Date:
		IAC No.

Judge Name:

IAC#

Assistant Name:

IAC#



Pilot NAC



B	Contest:	Category: Advanced	
	Date:	Program: Unknown	Pilot's No. <input type="text"/>

wind direction

Pilot
NAC

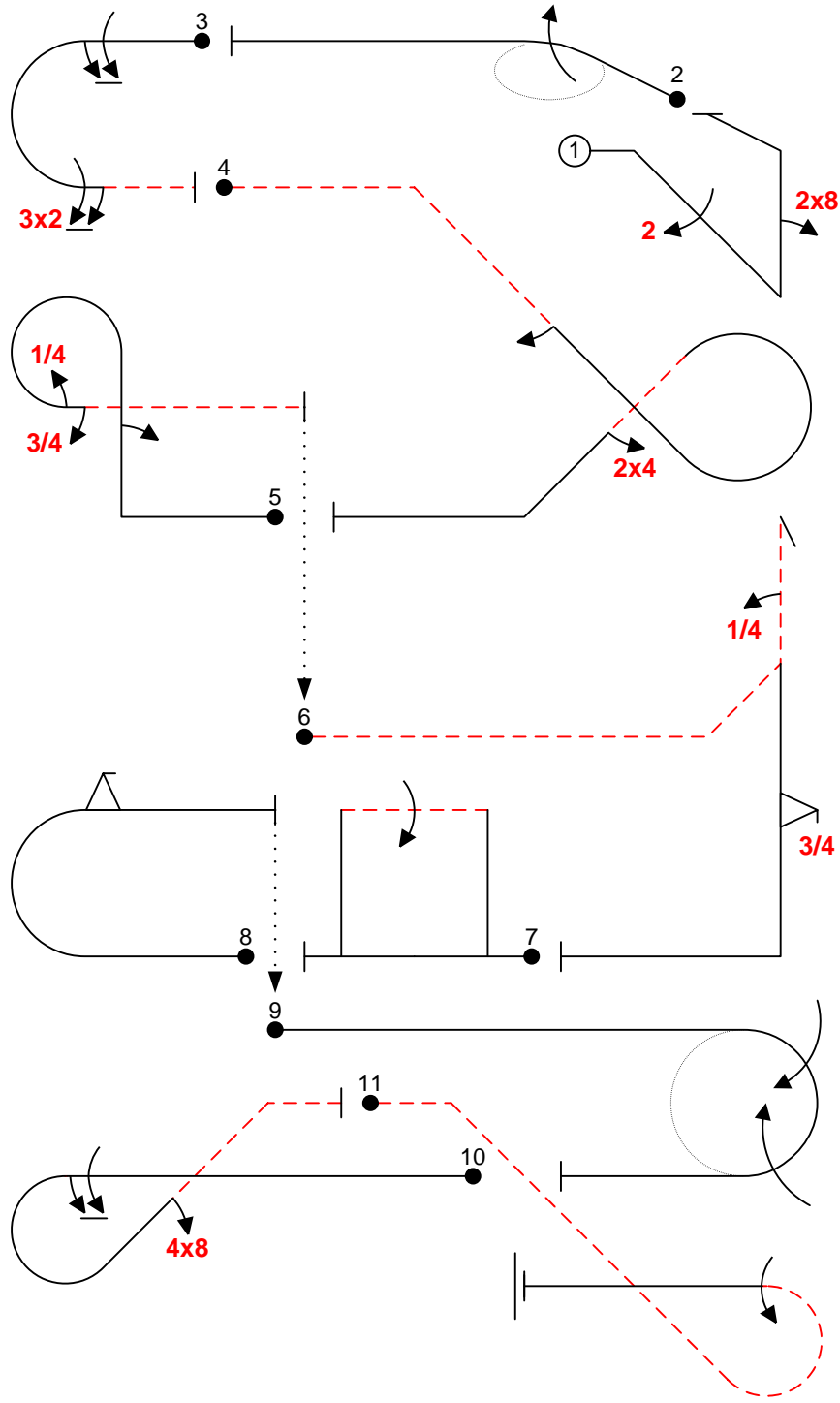

Created Using Aresti 2013™ software. ACCassidy@aol.com

FREE PROGRAM CHECK BY: (signature/date) A/C:



C	Contest:	Category: Advanced	
	Date:	Program: Unknown	Pilot's No. <input type="text"/>

pilot

NAC

wind direction

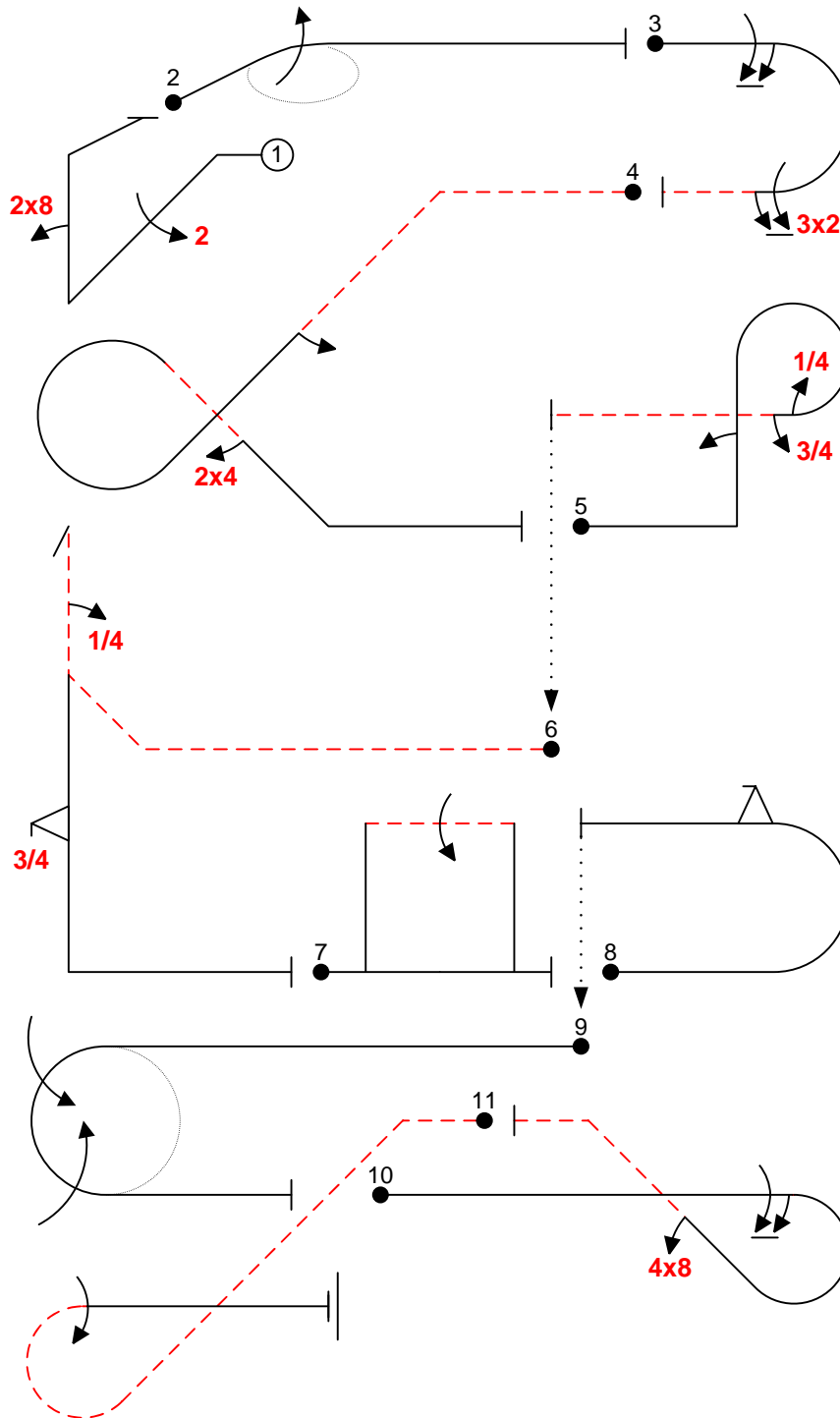

A/C:

(signature/date)

FREE PROGRAM CHECK BY: